

A *Nidec* Group Company

SERVO

All for dreams

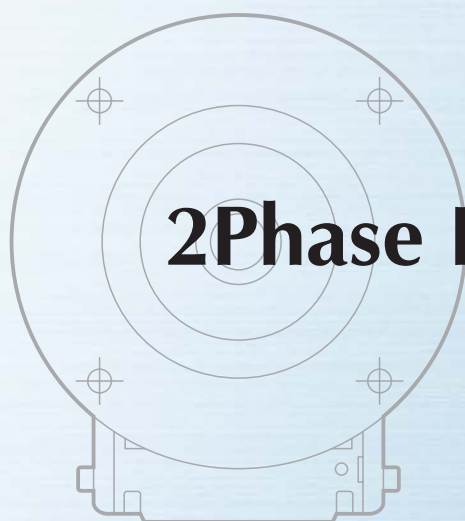

2Phase Hybrid Stepping Motors

KA Series

A new round motor with superior balance and a compact design.



Features

1. High torque
2. Low vibration
3. Silent operation
4. High position accuracy

The best magnetic balance is employed in our round type stepping motor. Motor performance is greatly improved using the latest technology of three dimensional magnetic field analysis and robust design.

Features (Compare to our current 42 & 56 square size motors)

Both high torque and low vibration performance were achieved.

- The round core provides the best magnetic balance. High torque performance is also achieved by optimizing the design with three dimensional magnetic field analysis. More than 30% higher holding torque was achieved and pull-out torque was also improved. (Refer to Fig. 1 and 2)

Fig. 1

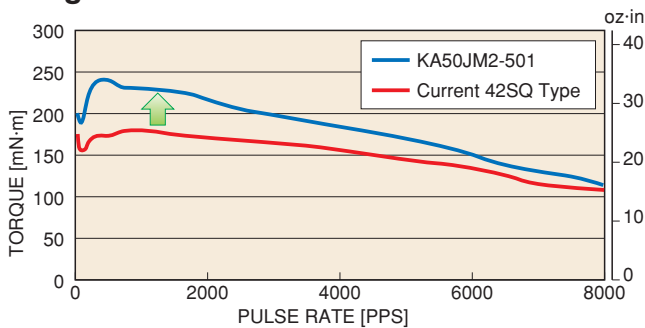
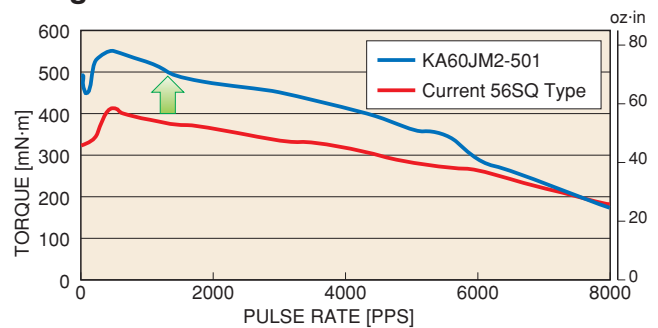
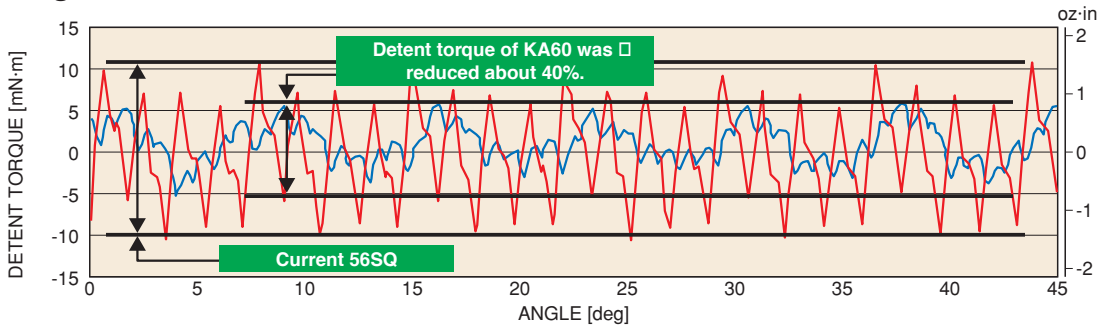

Fig. 2



- Low vibration and low rotational fluctuation were realized by reducing the detent torque using three dimensional magnetic field analysis. Rotational fluctuation was reduced about 30%.

Fig. 3



- Position accuracy was improved by minimizing the deviation of induced voltage. Position accuracy was improved about 30%. (Refer to Fig.4)

Fig. 4

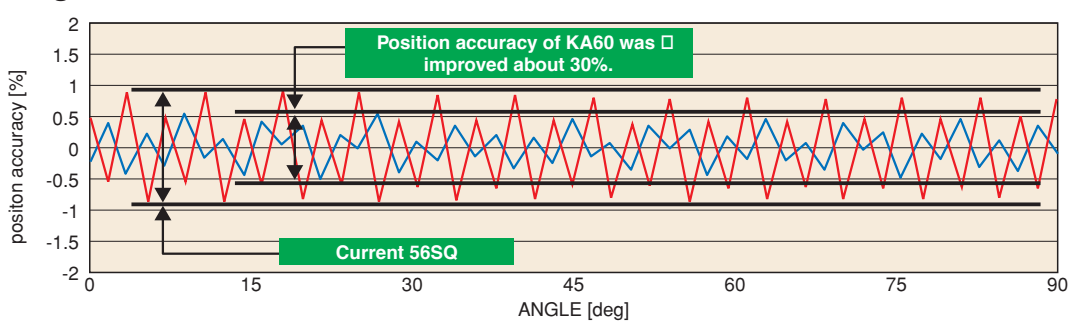

- Shaft size and mounting dimension compatibility between the 42sq. & KA50 and the 56sq. & KA60.
- Space Saving: High torque performance with shorter motor.
- All models are RoHS compliant.

- * Three dimensional magnetic field analysis: The magnetic strength is shown three dimensionally and the highest efficiency core shape is determined.
- * Robust design: A design method that is not influenced by the variation in parts to eliminate product performance variation.

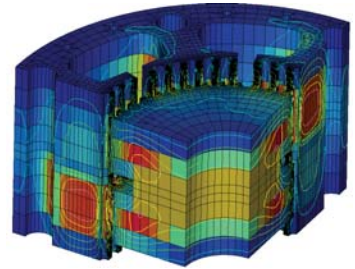

Max. Allowable Load / Runout for Motor Shaft

Load for Motor Shaft

Type	Thrust load	Radial load	
		Load	L
KA50	14.7 N [1.5 kgf] [3.3 lb]	19.6 N [2.0 kgf] [4.4 lb]	10 mm
KA60	40 N [4.1 kgf] [9.0 lb]	70 N [7.1 kgf] [15.8 lb]	

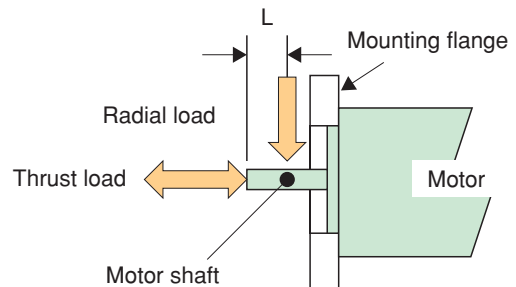

Shaft Run Out

Shaft run out	0.05 T.I.R. [mm]*
Concentricity between shaft and mounting circle	0.075 T.I.R. [mm]*
Perpendicularity between shaft and mounting face	0.075 T.I.R. [mm]*

* T.I.R. (Total Indicator Reading)

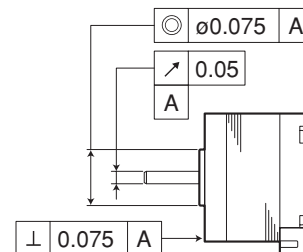

Specification

Temperature rise	70 K max (By resistance method)
Insulation class	Class E equivalent
Insulation resistance	100 MΩ min. At 500 V DC (at normal temp. & humidity, between lead and case)
Dielectric strength	500 V AC 50 Hz for 1 minute (at normal temp. & humidity, between lead and case)
Ambient temp. range	-10 °C ~ +50 °C
Storage temperature range	-20 °C ~ +70 °C
Humidity range in operation and storage	5 % ~ 95 % RH (noncondensing)

KA50 Series (1.8 degree/step)

Standard Specifications

UNIPOLAR

Model	Step angle	Voltage	Current	Resistance	Inductance	Holding torque		Detent torque		Rotor inertia	
Dimension	degree/step	V/∅	A/∅	Ω/∅	mH/∅	mN·m	oz·in	mN·m	oz·in	g·cm ²	oz·in ²
KA50HM2-501	1.8	2.08	2.0	1.04	0.9	216	31	12	1.7	50	0.3
KA50HM2-502		4.20	1.0	4.2	3.8	216	31	12	1.7	50	0.3
KA50JM2-501		2.46	2.0	1.23	1.3	324	46	15	2.1	70	0.4
KA50JM2-502		5.00	1.0	5.0	5.4	324	46	15	2.1	70	0.4
KA50KM2-501		3.20	2.0	1.6	1.8	471	67	20	2.8	100	0.5
KA50KM2-502		6.20	1.0	6.2	6.7	471	67	20	2.8	100	0.5

BIPOLAR

Model	Step angle	Voltage	Current	Resistance	Inductance	Holding torque		Detent torque		Rotor inertia	
Dimension	degree/step	V/∅	A/∅	Ω/∅	mH/∅	mN·m	oz·in	mN·m	oz·in	g·cm ²	oz·in ²
KA50HM2-551	1.8	1.66	2.0	0.83	1.3	231	33	12	1.7	50	0.3
KA50HM2-552		3.20	1.0	3.20	5.1	231	33	12	1.7	50	0.3
KA50JM2-551		1.96	2.0	0.98	1.9	373	53	15	2.1	70	0.4
KA50JM2-552		3.80	1.0	3.8	7.1	373	53	15	2.1	70	0.4
KA50KM2-551		2.60	2.0	1.30	2.5	520	74	20	2.8	100	0.5
KA50KM2-552		5.10	1.0	5.10	10	520	74	20	2.8	100	0.5

Outline unit = mm (inch)

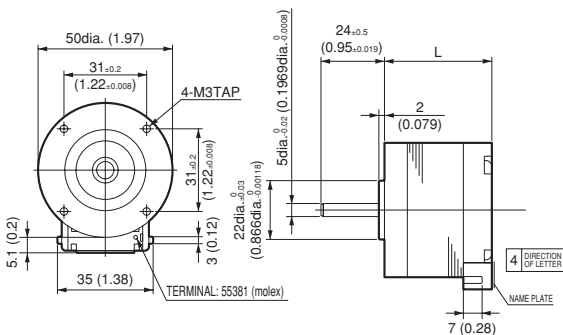

model	L[mm]	L[inch]	mass[g]	weight[lb]
KA50HM2	35	1.38	230	0.5
KA50JM2	40	1.57	300	0.7
KA50KM2	50	1.97	420	0.9

Accessories: Lead assy

UNIPOLAR

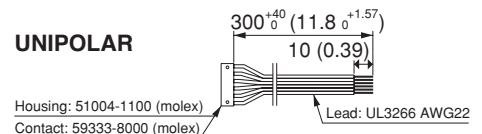

BIPOLAR

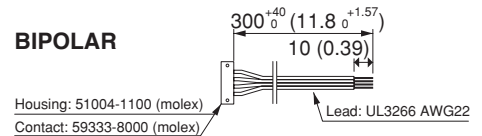

Connection Diagrams

Rotational direction

UNIPOLAR

(PHASE) 55381 PIN No. 55381 (PHASE) CW viewed from rotor shaft when using the following sequence diagram.

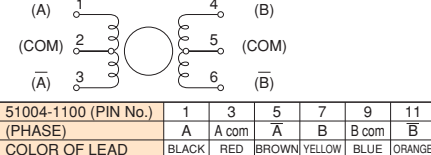

EXCITING SEQUENCE

55381 PIN No.	51004-1100 PIN No.	PHASE	1	2	3	4
1	1	A	-	-	-	-
4	7	A	-	-	-	-
3	5	B	-	-	-	-
6	11	B	-	-	-	-
2	3	A com	+	+	+	+
5	9	B com	+	+	+	+

BIPOLAR

(PHASE) 55381 PIN No. 55381 (PHASE) CW viewed from rotor shaft when using the following sequence diagram.

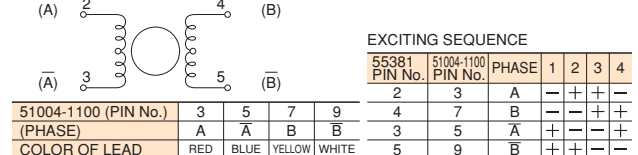

Speed-Torque Characteristics

UNIPOLAR

KA50HM2-501

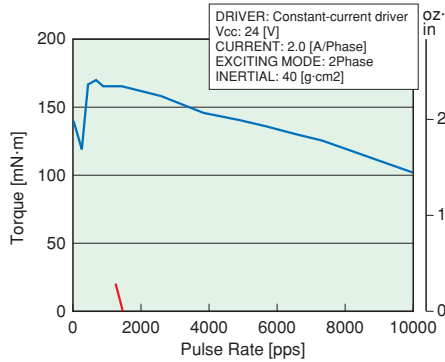

KA50JM2-501

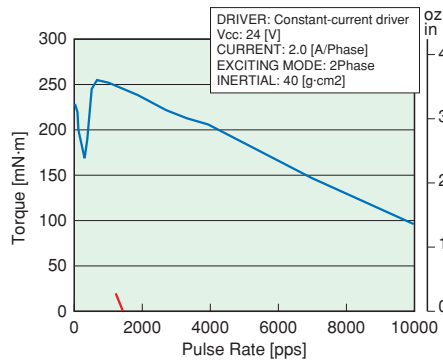

KA50KM2-501

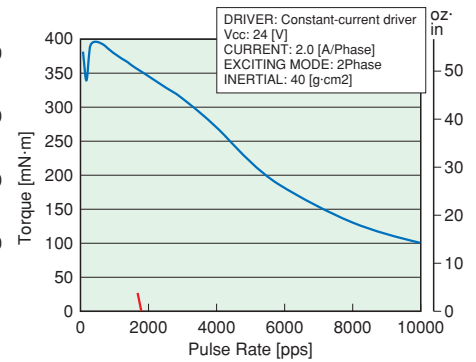

KA50HM2-502

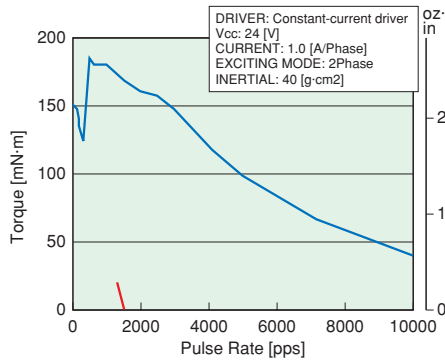

KA50JM2-502

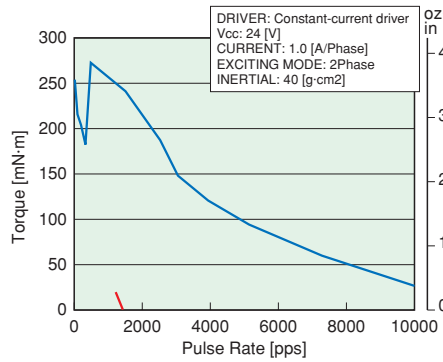

KA50KM2-502

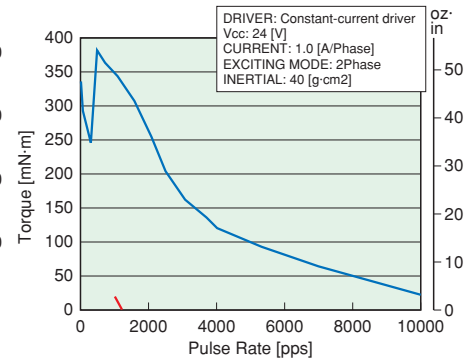

BIPOLAR

KA50HM2-551

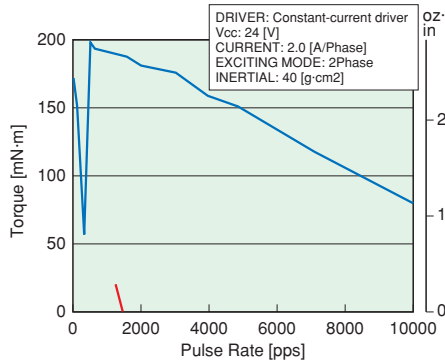

KA50JM2-551

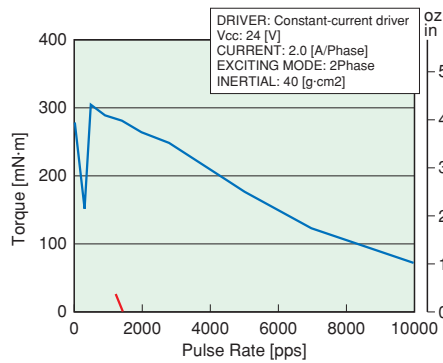

KA50KM2-551

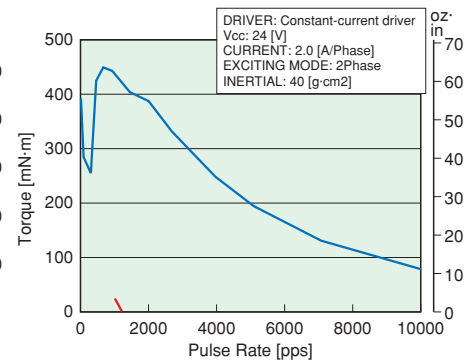

KA50HM2-552

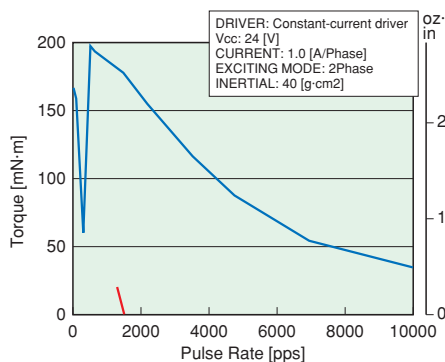

KA50JM2-552

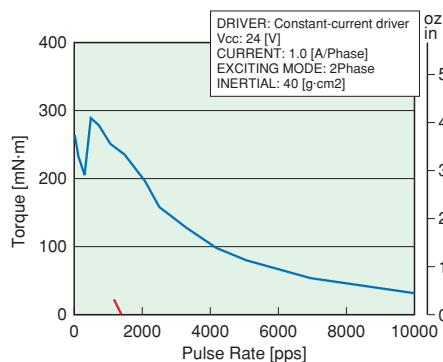

KA50KM2-552

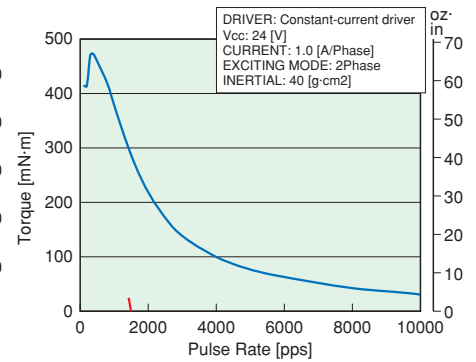

KA60 Series (1.8 degree/step)

Standard Specifications



UNIPOLAR

Model	Step angle	Voltage	Current	Resistance	Inductance	Holding torque		Detent torque		Rotor inertia	
Dimension	degree/step	V/∅	A/∅	Ω/∅	mH/∅	mN·m	oz·in	mN·m	oz·in	g·cm ²	oz·in ²
KA60JM2-501	1.8	2.44	3.3	0.74	0.83	707	100	35	5.0	180	1.0
KA60JM2-502		3.41	2.2	1.55	1.8	707	100	35	5.0	180	1.0
KA60KM2-501		2.97	3.3	0.9	1.4	1011	143	50	7.1	270	1.5
KA60KM2-502		4.40	2.2	2.0	3.0	1011	143	50	7.1	270	1.5
KA60LM2-501		3.63	3.3	1.10	1.6	1315	186	60	8.5	360	2.0
KA60LM2-502		5.28	2.2	2.4	3.4	1315	186	60	8.5	360	2.0

BIPOLAR

Model	Step angle	Voltage	Current	Resistance	Inductance	Holding torque		Detent torque		Rotor inertia	
Dimension	degree/step	V/∅	A/∅	Ω/∅	mH/∅	mN·m	oz·in	mN·m	oz·in	g·cm ²	oz·in ²
KA60JM2-551	1.8	2.05	3.3	0.62	1.2	805	114	35	5.0	180	1.0
KA60JM2-552		2.42	2.2	1.10	2.6	805	114	35	5.0	180	1.0
KA60KM2-551		2.41	3.3	0.73	2.1	1207	171	50	7.1	270	1.5
KA60KM2-552		3.01	2.2	1.37	4.5	1207	171	50	7.1	270	1.5
KA60LM2-551		2.97	3.3	0.90	2.2	1600	227	60	8.5	360	2.0
KA60LM2-552		3.74	2.2	1.7	4.9	1600	227	60	8.5	360	2.0

Outline unit = mm (inch)

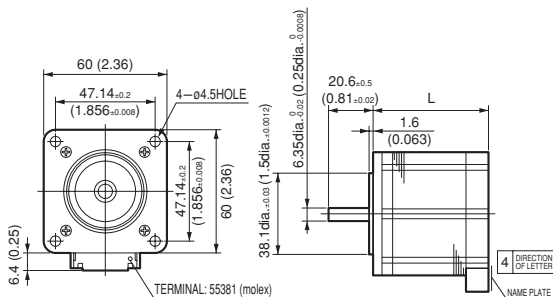

model	L[mm]	L[inch]	mass[g]	weight[lb]
KA60JM2	44	1.73	500	1.1
KA60KM2	54	2.13	700	1.5
KA60LM2	65	2.56	850	1.9

Accessories: Lead assy

UNIPOLAR

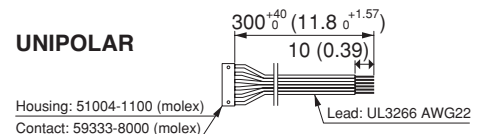

BIPOLAR

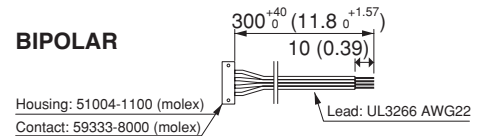

Connection Diagrams

Rotational direction

UNIPOLAR

(PHASE) 55381 PIN No. 55381 (PHASE) CW viewed from rotor shaft when using the following sequence diagram.

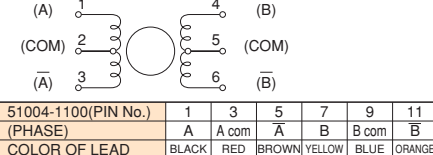

EXCITING SEQUENCE		PHASE	1	2	3	4
55381 PIN No.	51004-1100 PIN No.	A	-	-	-	-
4	7	B	-	-	-	-
3	5	A	-	-	-	-
6	11	B	-	-	-	-
2	3	A com	+	+	+	+
5	9	B com	+	+	+	+

BIPOLAR

(PHASE) 55381 PIN No. 55381 (PHASE) CW viewed from rotor shaft when using the following sequence diagram.

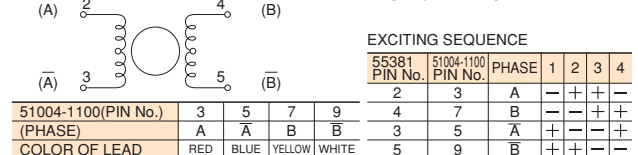

Speed-Torque Characteristics

UNIPOLAR

KA60JM2-501

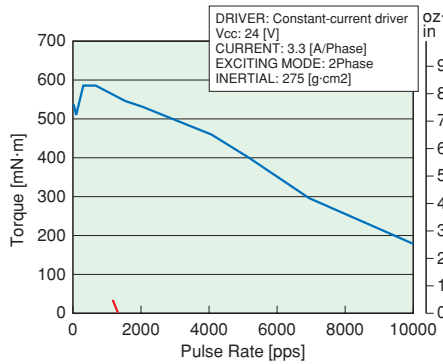

KA60KM2-501

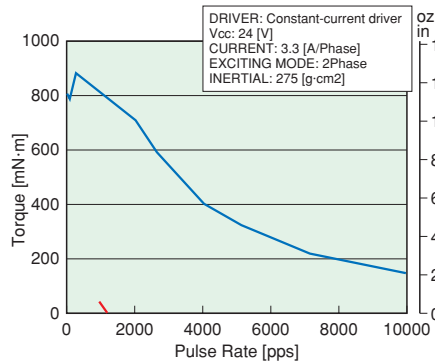

KA60LM2-501

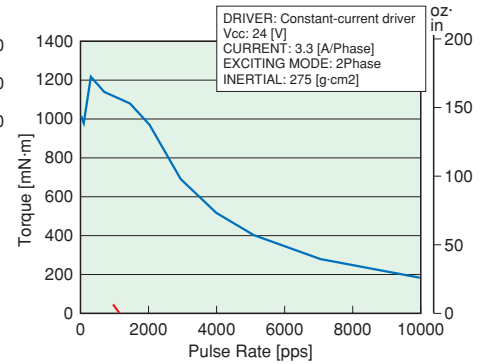

KA60JM2-502

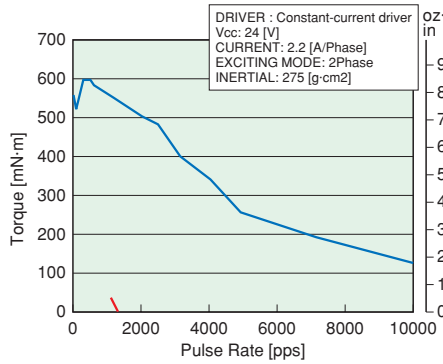

KA60KM2-502

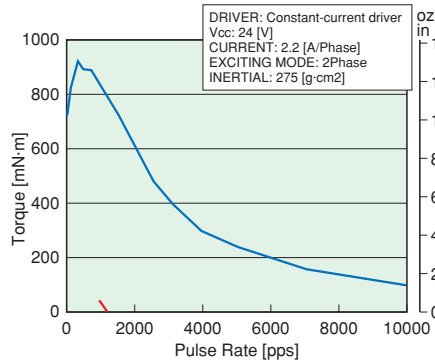

KA60LM2-502

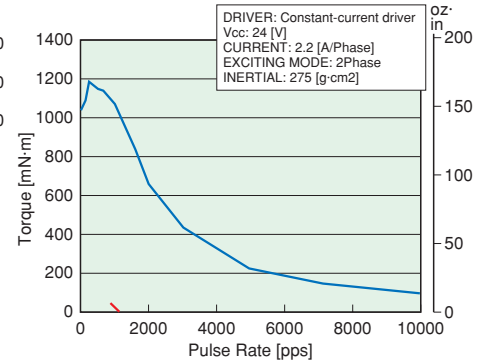

BIPOLAR

KA60JM2-551

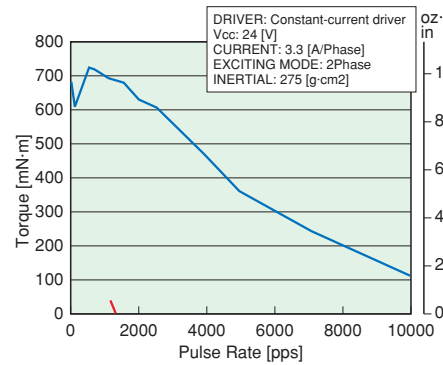

KA60KM2-551

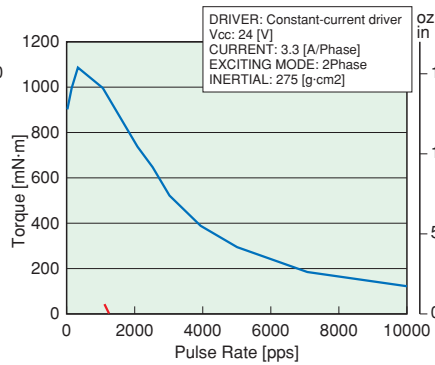

KA60LM2-551

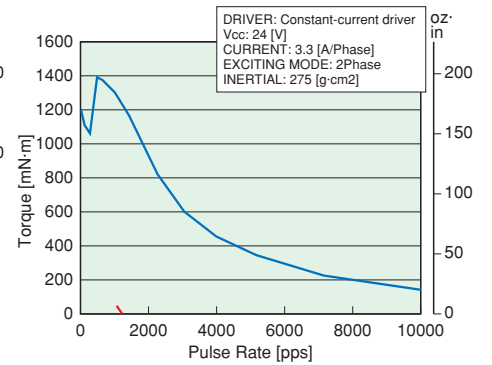

KA60JM2-552

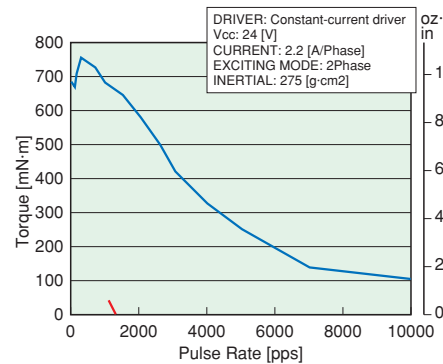

KA60KM2-552

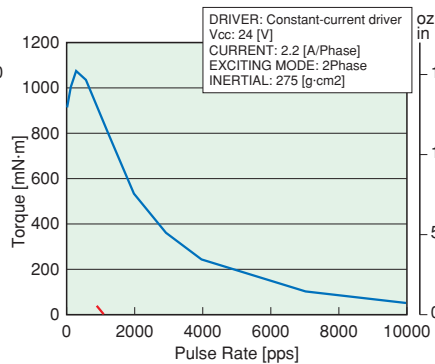

KA60LM2-552

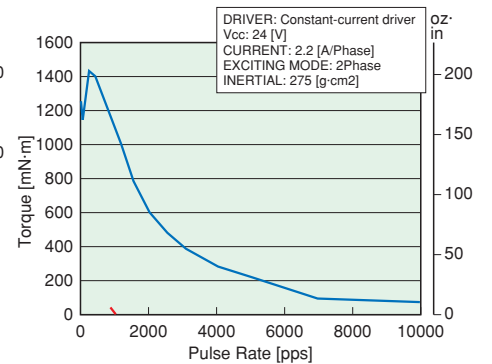

KA50 Series (0.9 degree/step)

High-resolution Motors Standard Specifications



UNIPOLAR

Model	Step angle	Voltage	Current	Resistance	Inductance	Holding torque		Detent torque		Rotor inertia	
Dimension	degree/step	V/∅	A/∅	Ω/∅	mH/∅	mN·m	oz·in	mN·m	oz·in	g·cm ²	oz·in ²
KA50HM1-501	0.9	2.12	2.0	1.06	1.15	185	26	10	1.4	50	0.3
KA50HM1-502		4.20	1.0	4.20	4.40	185	26	10	1.4	50	0.3
KA50JM1-501		2.46	2.0	1.23	1.60	304	43	12	1.7	70	0.4
KA50JM1-502		5.00	1.0	5.00	6.90	304	43	12	1.7	70	0.4
KA50KM1-501		3.32	2.0	1.66	2.10	403	57	18	2.5	100	0.5
KA50KM1-502		6.70	1.0	6.70	8.60	403	57	18	2.5	100	0.5

BIPOLAR

Model	Step angle	Voltage	Current	Resistance	Inductance	Holding torque		Detent torque		Rotor inertia	
Dimension	degree/step	V/∅	A/∅	Ω/∅	mH/∅	mN·m	oz·in	mN·m	oz·in	g·cm ²	oz·in ²
KA50HM1-551	0.9	1.66	2.0	0.83	1.60	215	30	10	1.4	50	0.3
KA50HM1-552		3.20	1.0	3.20	6.60	215	30	10	1.4	50	0.3
KA50JM1-551		1.96	2.0	0.98	2.30	347	49	12	1.7	70	0.4
KA50JM1-552		3.80	1.0	3.80	9.10	347	49	12	1.7	70	0.4
KA50KM1-551		2.60	2.0	1.30	3.10	458	65	18	2.5	100	0.5
KA50KM1-552		5.10	1.0	5.10	11.00	458	65	18	2.5	100	0.5

Outline unit = mm (inch)

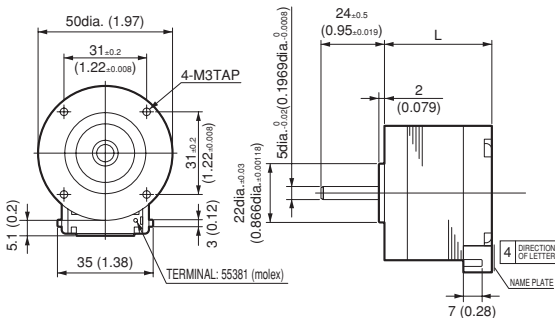

model	L[mm]	L[inch]	mass[g]	weight[lb]
KA50HM1	35	1.38	230	0.5
KA50JM1	40	1.57	300	0.7
KA50KM1	50	1.97	420	0.9

Accessories: Lead assy

UNIPOLAR

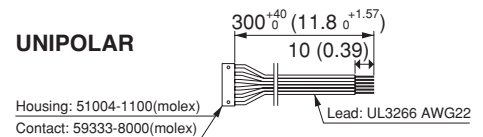

BIPOLAR

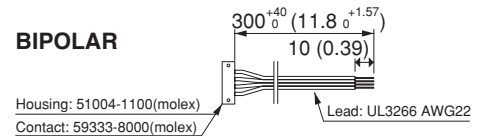

Connection Diagrams

Rotational direction

UNIPOLAR

(PHASE) 55381 PIN No. 55381 PIN No. (PHASE) CCW viewed from rotor shaft when using the following sequence diagram.

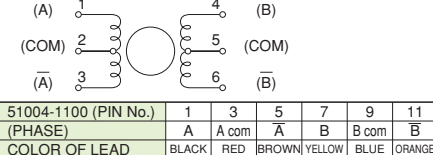

BIPOLAR

(PHASE) 55381 PIN No. 55381 PIN No. (PHASE) CCW viewed from rotor shaft when using the following sequence diagram.

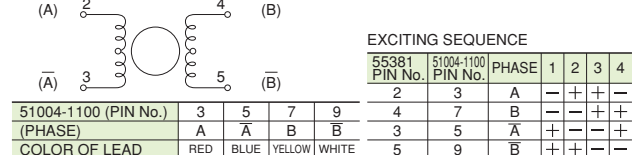

Speed-Torque Characteristics

UNIPOLAR

KA50HM1-501

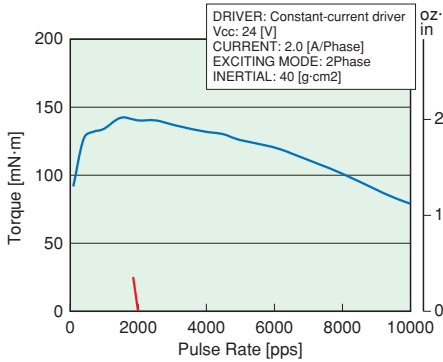

KA50JM1-501

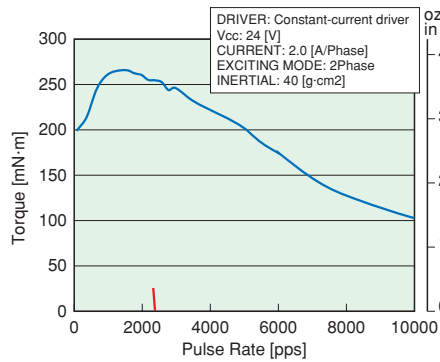

KA50KM1-501

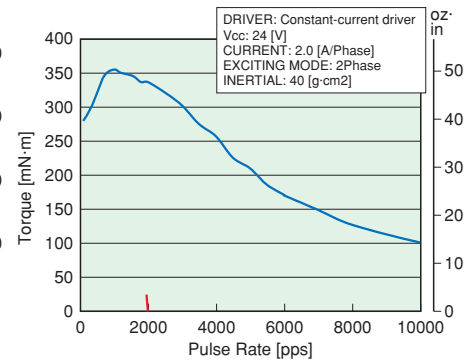

KA50HM1-502

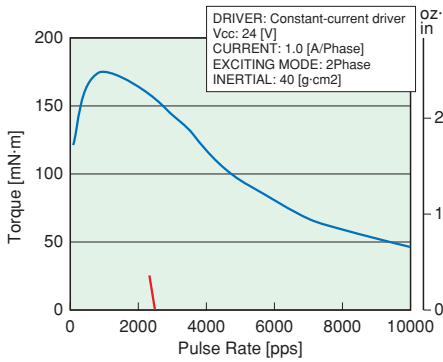

KA50JM1-502

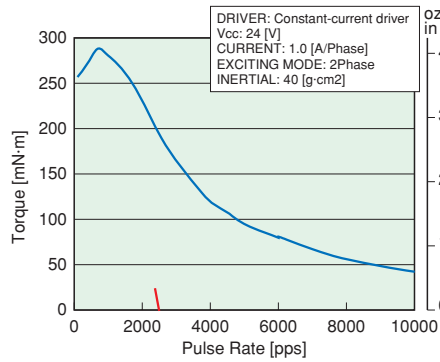

KA50KM1-502

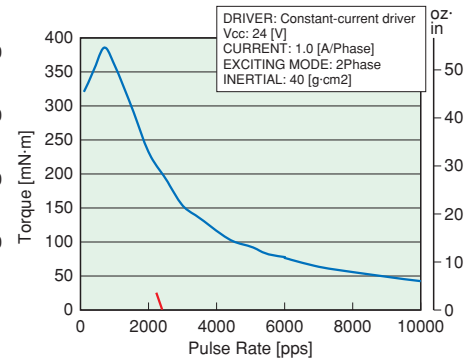

BIPOLAR

KA50HM1-551

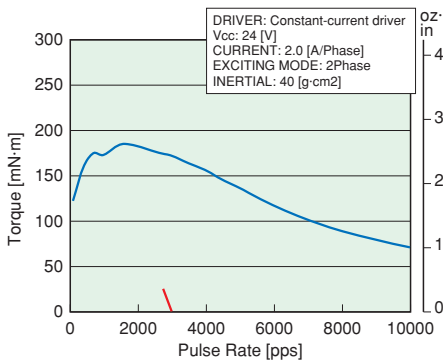

KA50JM1-551

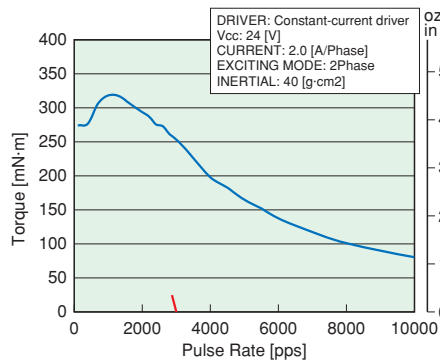

KA50KM1-551

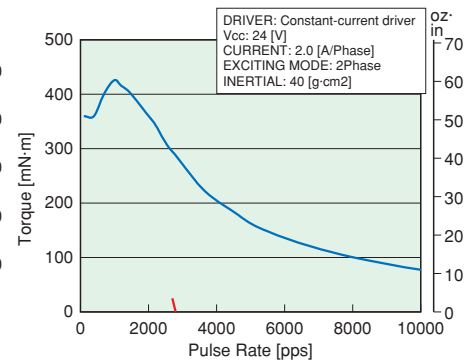

KA50HM1-552

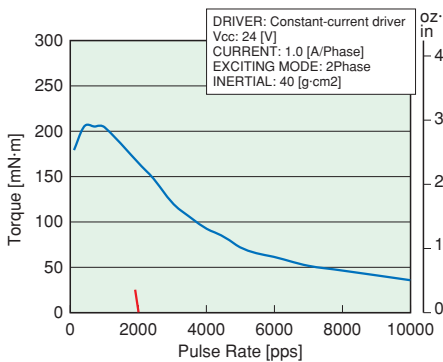

KA50JM1-552

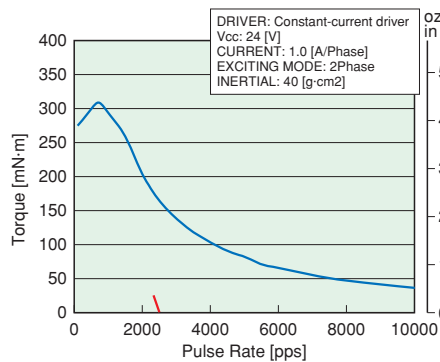

KA50KM1-552

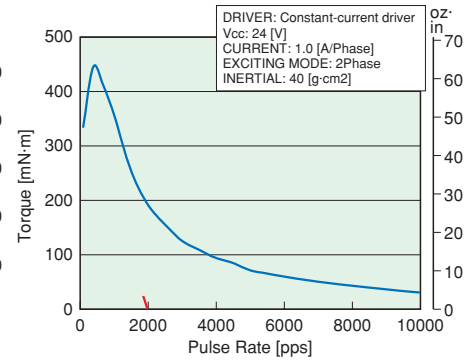

KA Series Semi-Standard

Motor with D-cut Single Shaft

(Model example)

KA50JM2-501 ⇒ KA50JM2-50101

Model List

	KA50 1.8 degree/step	KA60 1.8 degree/step	KA50 0.9 degree/step
UNIPOLAR	KA50HM2-50101	KA60JM2-50101	KA50HM1-50101
	KA50HM2-50201	KA60JM2-50201	KA50HM1-50201
	KA50JM2-50101	KA60KM2-50101	KA50JM1-50101
	KA50JM2-50201	KA60KM2-50201	KA50JM1-50201
	KA50KM2-50101	KA60LM2-50101	KA50KM1-50101
BIPOLAR	KA50HM2-55101	KA60JM2-55101	KA50HM1-55101
	KA50HM2-55201	KA60JM2-55201	KA50HM1-55201
	KA50JM2-55101	KA60KM2-55101	KA50JM1-55101
	KA50JM2-55201	KA60KM2-55201	KA50JM1-55201
	KA50KM2-55101	KA60LM2-55101	KA50KM1-55101

The basic motor characteristics, connection diagrams, and accessories (lead connectors) conform to the standard specifications.

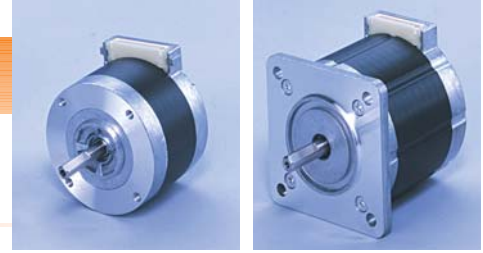

Outline unit = mm (inch) Single shaft specification

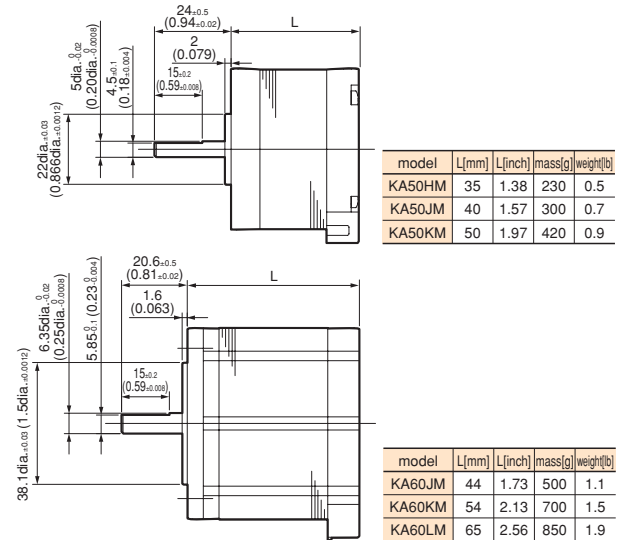

Motor with D-cut Double Shaft

(Model example)

UNIPOLAR KA50JM2-501 ⇒ KA50JM2-511

BIPOLAR KA50JM2-551 ⇒ KA50JM2-561

Model List

	KA50 1.8 degree/step	KA60 1.8 degree/step	KA50 0.9 degree/step
UNIPOLAR	KA50HM2-511	KA60JM2-511	KA50HM1-511
	KA50HM2-512	KA60JM2-512	KA50HM1-512
	KA50JM2-511	KA60KM2-511	KA50JM1-511
	KA50JM2-512	KA60KM2-512	KA50JM1-512
	KA50KM2-511	KA60LM2-511	KA50KM1-511
BIPOLAR	KA50HM2-561	KA60JM2-561	KA50HM1-561
	KA50HM2-562	KA60JM2-562	KA50HM1-562
	KA50JM2-561	KA60KM2-561	KA50JM1-561
	KA50JM2-562	KA60KM2-562	KA50JM1-562
	KA50KM2-561	KA60LM2-561	KA50KM1-561

The basic motor characteristics, connection diagrams, and accessories (lead connectors) conform to the standard specifications.

Outline unit = mm (inch) Double shaft specification

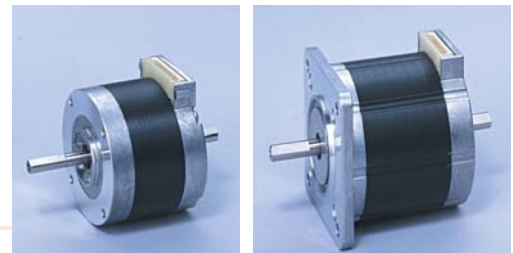
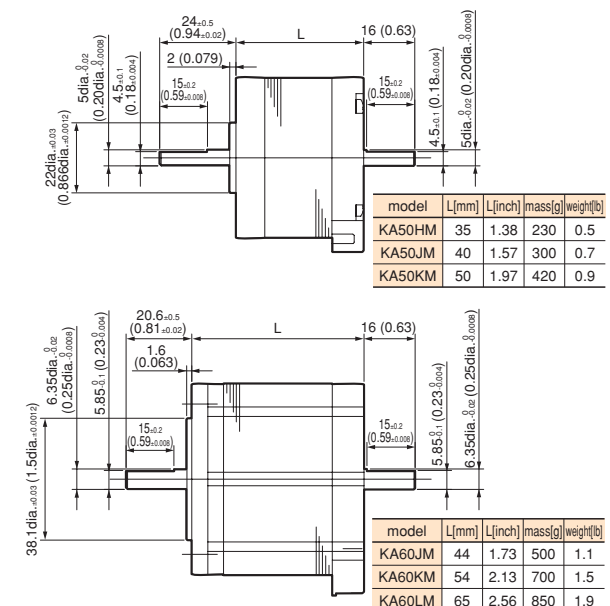

Motor with Encoder

(Model example)

KA50JM2-501 ⇒ 2 Channel KA50JM2E2-501

3 Channel KA50JM2E3-501

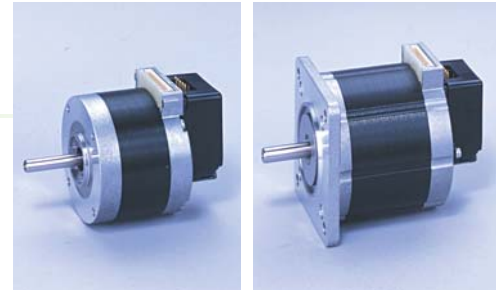

Model List

	KA50 1.8 degree/step			KA60 1.8 degree/step		
	Base motor	2 Channel	3 Channel	Base motor	2 Channel	3 Channel
UNIPOLAR	KA50HM2-501	KA50HM2E2-501	KA50HM2E3-501	KA60JM2-501	KA60JM2E2-501	KA60JM2E3-501
	KA50HM2-502	KA50HM2E2-502	KA50HM2E3-502	KA60JM2-502	KA60JM2E2-502	KA60JM2E3-502
	KA50JM2-501	KA50JM2E2-501	KA50JM2E3-501	KA60KM2-501	KA60KM2E2-501	KA60KM2E3-501
	KA50JM2-502	KA50JM2E2-502	KA50JM2E3-502	KA60KM2-502	KA60KM2E2-502	KA60KM2E3-502
	KA50KM2-501	KA50KM2E2-501	KA50KM2E3-501	KA60LM2-501	KA60LM2E2-501	KA60LM2E3-501
	KA50KM2-502	KA50KM2E2-502	KA50KM2E3-502	KA60LM2-502	KA60LM2E2-502	KA60LM2E3-502
BIPOLAR	KA50HM2-551	KA50HM2E2-551	KA50HM2E3-551	KA60JM2-551	KA60JM2E2-551	KA60JM2E3-551
	KA50HM2-552	KA50HM2E2-552	KA50HM2E3-552	KA60JM2-552	KA60JM2E2-552	KA60JM2E3-552
	KA50JM2-551	KA50JM2E2-551	KA50JM2E3-551	KA60KM2-551	KA60KM2E2-551	KA60KM2E3-551
	KA50JM2-552	KA50JM2E2-552	KA50JM2E3-552	KA60KM2-552	KA60KM2E2-552	KA60KM2E3-552
	KA50KM2-551	KA50KM2E2-551	KA50KM2E3-551	KA60LM2-551	KA60LM2E2-551	KA60LM2E3-551
	KA50KM2-552	KA50KM2E2-552	KA50KM2E3-552	KA60LM2-552	KA60LM2E2-552	KA60LM2E3-552

Outline unit = mm (inch)

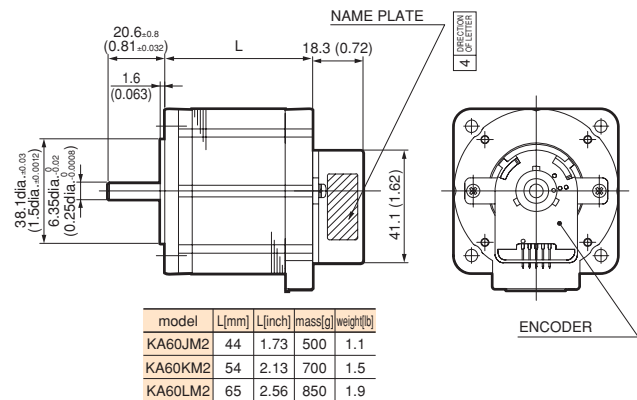
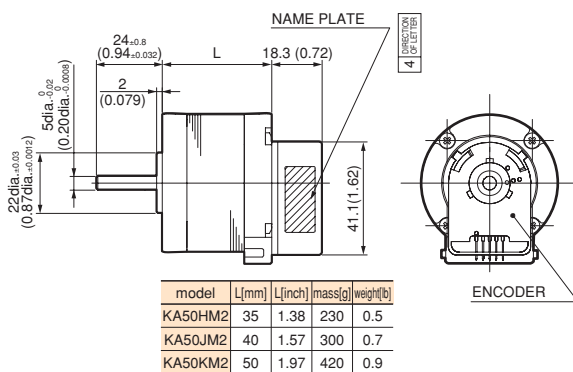

Encoder specification

	KA50, KA60
Resolution [P/R]	400
Power-supply voltage	DC 5V ±0.5 V
Output aspect	2 Channel (A, B aspect) or 3 Channel (A, B, I aspect)
Output wave form	TTL

Recommended pull-up resistor value

	2 Channel	3 Channel
R [Ω]	11 k	2.7 k

The basic motor characteristics, connection diagrams, and accessories (lead connectors) conform to the standard specifications.

Connection diagrams

2 Channel

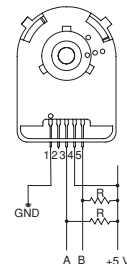

PIN No.	1	2	3	4	5
Connection	GND	—	A aspect	+5 V	B aspect

3 Channel

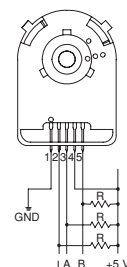

PIN No.	1	2	3	4	5
Connection	GND	I aspect	A aspect	+5 V	B aspect



www.japanservo.com
Japan Servo Co., Ltd., Sales Headquarters
7 Kanda-Mitoshirocho
Chiyodaku, Tokyo 101-0053 Japan
Tel: +81- (0) 3-3292-3506
Fax: +81- (0) 3-3292-3509

Japan Servo USA Inc.
2050 Center Ave. Suite 318
Fort Lee, NJ 07024
Tel: +1- (0) 201-585-0720
Fax: +1- (0) 201-585-0670

Japan Servo Co., Ltd. Europe Branch
PO Box 1099, 3840 BB Harderwijk
The Netherlands
Tel: +31- (0) 3414-27575
Fax: +31- (0) 3414-23388

PO Box 7084, Hook, Hampshire, RG27 9XL, UK
Tel: +44- (0) 1256-767712
Fax: +44- (0) 1256-767715

Japan Servo Co., Ltd. Singapore Branch
No. 50, Kallang Avenue #05-01,
Noel Corporate Buildings, Singapore 339505
Tel: +65- (0) 6743-7655
Fax: +65- (0) 6842-7839

Japan Servo (Hong Kong) Limited
Unit 1008-09, Saxon Tower, 7 Cheung Shun Street,
Lai Chi Kok, Kowloon, HONG KONG
Tel: +852- (0) 2314-0037
Fax: +852- (0) 2314-4768

**Japan Servo (Hong Kong) Limited
Taiwan Representative Office**
Rm.1001, No.88, Sec.2,
Chung Shan N.Rd., Taipei 104 Taiwan
Nidec Taiwan Corporation.
FAX +852- (0) 3007-8924

WARNING

- Please do not exceed the specifications noted in this catalogue, otherwise there is a chance of electric shock, injury, or other damage.
- Any modifications made to this motor are beyond the limits of our guarantee. Japan Servo cannot take responsibility for any customer modifications.
- Please ensure that a thorough evaluation has been done before using this motor in medical equipment or other devices related to human lives.
- Please ensure that a thorough evaluation has been done before using this motor in applications that have a serious effect on the public.

NOTE

- Figures in this catalogue are average measured values. Please request the product delivery specification when preparing a purchase specification.
- The dimensions, specifications, and components contained in this catalogue are subject to change without prior notice due to further product improvements.