

RAFIX 22 FS keylock switch, round collar

1.30.255.002/0000

Other lock variants available on request.



Included: 2 keys.

General information

Form of collar	round
Colour of front ring	metallized

Dimensions

Overall height	44.1 mm
Width of collar	---
Diameter of collar	29.8 mm
Length of collar	---
Mounting depth	9.2 mm
Mounting hole	22.3 mm
Key grid	30 x 30 mm

Mechanical characteristics

Torque max.	1.3 Nm
-------------	--------

Mechanical design

Key removal position	0
Number of locking positions	500
Mounting	ring nut
Illuminability	no
Rotating angle	1 x 40°
Main key	no
Contact function	momentary
Lock type	001
Lock	Micromec
Symmetric key	no
Wafers	5

Other specifications

Ambient temp. operating max.	+70 °C
Ambient temp. operating min.	-25 °C
ESD-strength lock / contact	15 kV
ESD-strength key/ front panel	15 kV
Resistance to constant environment	IEC 600 68-2-3 and 2-30
Storage temperature max.	+80 °C
Storage temperature min.	-40 °C
Operating life	0.3 million momentary / 50000 latching
Salt spray	IEC 600 68-2-11
Degree of protection from front side	IP65
Resistance at variable environment	IEC 600 68-2-14 and 2-33

21.05.2008

MASS

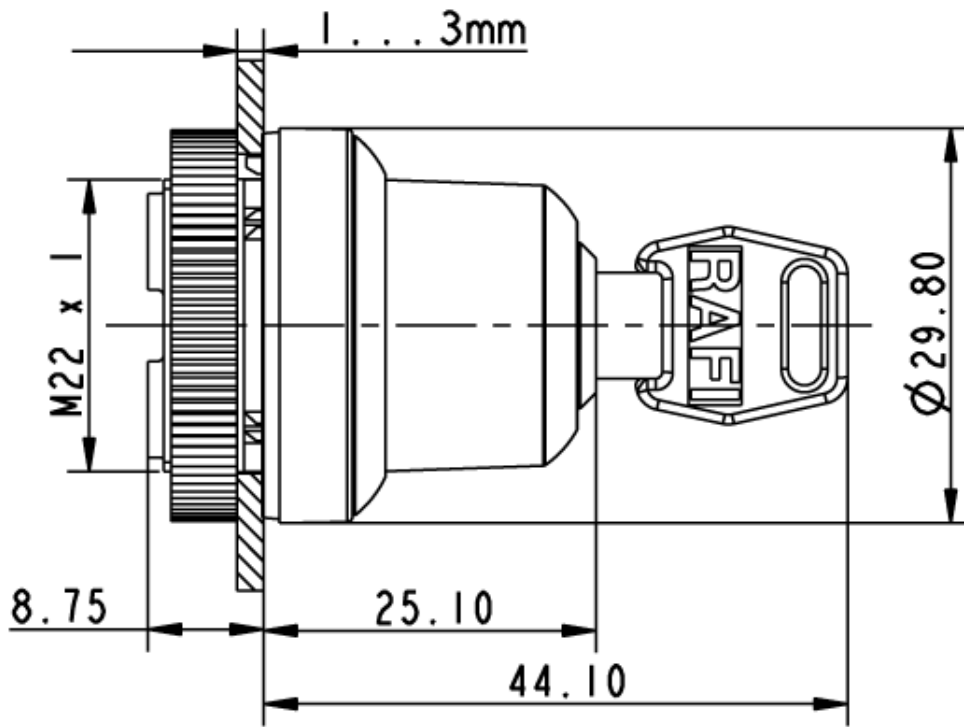

Else

